

Signet 515 Rotor-X Paddlewheel Flow Sensors

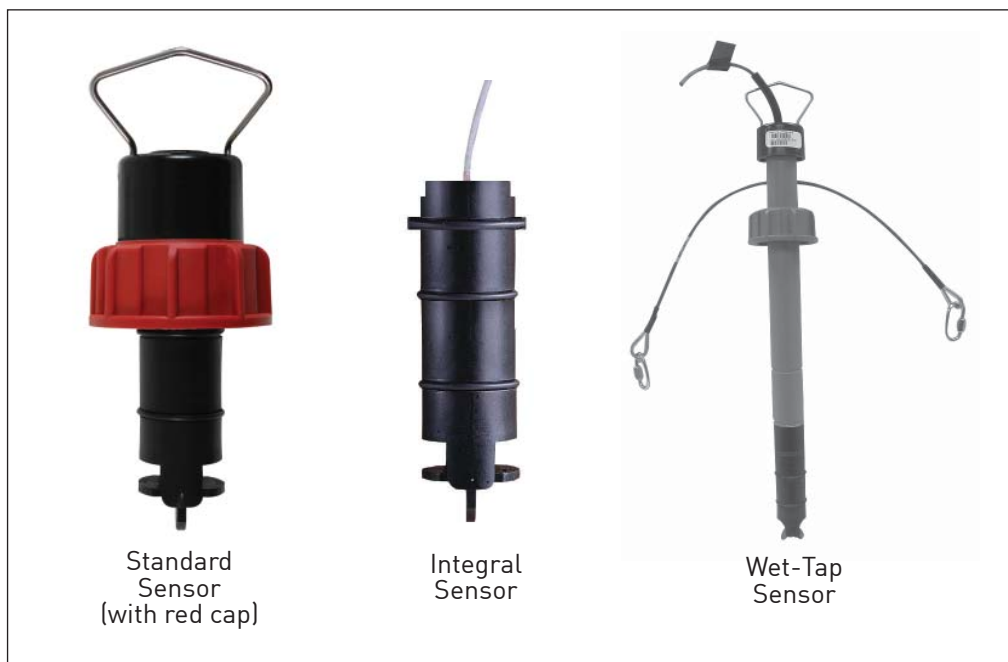

Standard Sensor
(with red cap)

Integral Sensor

Wet-Tap Sensor

Features

- Operating range 0.3 to 6 m/s (1 to 20 ft/s)
- Wide turndown ratio of 20:1
- Highly repeatable output
- Simple, economical design
- Installs into pipe sizes DN15 to DN900 (½ to 36 in.)
- Self-powered/no external power required
- Test certificate included for -X0, -X1
- Chemically resistant materials

Description







Simple to install with time-honored reliable performance, Signet 515 Rotor-X Paddlewheel Flow Sensors are highly repeatable, rugged sensors that offer exceptional value with little or no maintenance. The output signal of the Model 515 is a sinusoidal frequency capable of driving a self-powered flowmeter (Model 3-5090). The wide dynamic flow range of 0.3 to 6 m/s (1 to 20 ft/s) allows the sensor to measure liquid flow rates in full pipes and can be used in low pressure systems.

The Model 515 sensors are offered in a variety of materials for a wide range of pipe sizes and insertion configurations. The many material choices including PP and PVDF make this model highly versatile and chemically compatible to many liquid process solutions. Sensors can be installed in up to DN900 (36 in.) pipes using Signet's comprehensive line of custom fittings. These custom fittings, which include tees, saddles, and weldolets, seat the sensor to the proper insertion depth into the process flow. The sensors are also offered in configurations for wet-tap and intrinsically safe installation requirements.

Applications

- Pure Water Production
- Filtration Systems
- Chemical Production
- Liquid Delivery Systems
- Pump Protection
- Scrubber Systems
- Water Monitoring
- Not suitable for gases

System Overview (For overview of Wet-Tap System, see 3519 product page)

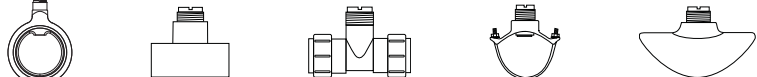
<p>Panel Mount Signet Flow Instrument (sold separately) 5075 8150 5090 8550 5500 8900 5600</p> 	<p>Pipe, Tank, Wall Mount Signet Flow Instrument (sold separately) 8150 8550</p> 	<p>Integral Mount Signet Flow Instrument (sold separately) 8150 8550</p> 
<p>Signet Model 515 Standard or Wet-Tap (not shown) Flow Sensor</p> 	<p>Signet Model 515 Standard or Wet-Tap (not shown) Flow Sensor</p> 	<p>Signet Model 515 Integral Mount Flow Sensor</p> 
<p>Signet Fittings* (sold separately)</p> 		



* See Fittings section for more information.

Dimensions

515 Standard Mount Sensor

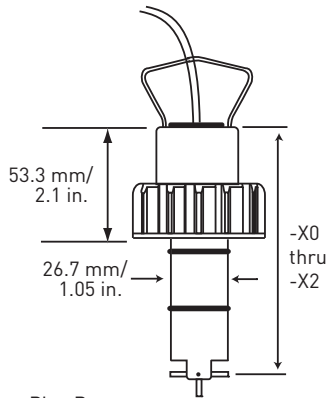

Pipe Range
 ½ to 4 in.: -X0 = 104 mm (4.1 in.)
 5 to 8 in.: -X1 = 137 mm (5.4 in.)
 10 in. and up: -X2 = 213 mm (8.4 in.)

515 Integral Mount Sensor shown with Transmitter (sold separately)

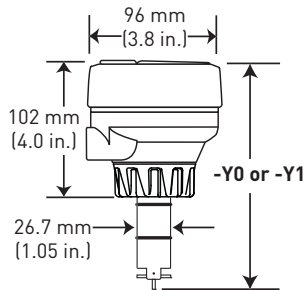

Pipe Range
 0.5 to 4 in. -Y0 = 152mm (6.0 in.)
 5 to 8 in. -Y1 = 185mm (7.3 in.)

515 Wet-Tap Mount Sensor with 3519 Wet-Tap Valve

See more information on the 3519 Wet-Tap Valve, refer to the 3519 product page.

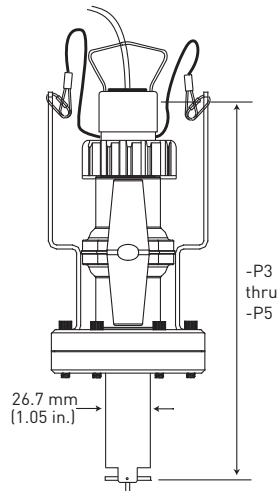

Pipe Range
 ½ to 4 in. -P3 = 297 mm (11.7 in.)
 5 to 8 in. -P4 = 333 mm (13.1 in.)
 10 in. and up -P5 = 409 mm (16.1 in.)

Specifications

General

Operating Range:
 0.3 to 6 m/s (1 to 20 ft/s)
 Pipe Size Range:
 DN15 to DN900 (½ to 36 in.)
 Linearity:
 ±1% of max. range @ 25 °C (77 °F)
 Repeatability:
 ±0.5% of max. range @ 25 °C (77 °F)
 Min. Reynolds Number Required: 4500

Wetted Materials

- Sensor Body:
 Glass-filled PP (black) or PVDF (natural)
- O-rings:
 FPM (std)
 optional EPR (EPDM) or FFPM
- Rotor Pin:
 Titanium, Hastelloy-C or PVDF;
 optional Ceramic, Tantalum, or Stainless Steel
- Rotor:
 Black PVDF or Natural PVDF;
 optional Tefzel®, with or without Fluoroloy G® sleeve

Electrical

Frequency:
 19.7 Hz per m/s nominal
 (6 Hz per ft/s); sinusoidal
 Amplitude:
 3.3 V p/p per m/s nominal
 (1 V p/p per ft/s)
 Source Impedance: 8 KΩ

Cable Type:

2-conductor twisted pair with shield,
 22 AWG

Cable Length:

7.6 m (25 ft) can be extended up to 60 m
 (200 ft) maximum

Max. Temperature/Pressure Rating Standard and Integral Sensor

- PP: 12.5 bar @ 20 °C,
 1.7 bar @ 90 °C
 (180 psi @ 68 °F, 25 psi @ 194 °F)
 - PVDF: 14 bar @ 20 °C,
 1.4 bar @ 100 °C
 (200 psi @ 68 °F, 20 psi @ 212 °F)
- Operating Temperature:
 • PP: -18 °C to 90 °C (0 °F to 194 °F)
 • PVDF: -18 °C to 100 °C (0 °F to 212 °F)

Wet-Tap Sensor

- PP: 7 bar @ 20 °C, 1.4 bar @ 66 °C
 (100 psi @ 68 °F, 20 psi @ 150 °F)
- Operating temperature:
 -18 °C to 66 °C (0 °F to 150 °F)
 Max. wet-tap sensor removal rating:
 1.7 bar @ 22 °C (25 psi @ 72 °F)

See Temperature and Pressure Graphs for more information.

Shipping Weight

P51530-X0	0.454 kg	1.00 lb
P51530-X1	0.476 kg	1.04 lb
P51530-X2	0.680 kg	1.50 lb
P51530-X3	0.794 kg	1.75 lb
P51530-X4	0.850 kg	1.87 lb
P51530-X5	1 kg	2.20 lb
3-8510-X0	0.23 kg	.50 lb
3-8510-X1	0.23 kg	.50 lb

Standards and Approvals

- FM Class I, II, III/Div. 1/groups A-G
- RoHS compliant
- Manufactured under ISO 9001 for Quality and ISO 14001 for Environmental Management

Application Tips:

- Use the Conduit Adapter Kit to protect the cable-to-sensor connection when used in outdoor environments. See Accessories section for more information.
- Use a sleeved rotor in abrasive liquids to reduce wear.
- Sensor plug can be used to plug installation fitting after extraction of sensor from pipe.

- For liquids containing ferrous particles, use Signet Magmeters.
- For systems with components of more than one material, the maximum temperature/pressure specification must always be referenced to the component with the lowest rating.

Please refer to Wiring, Installation, Accessories and Fittings sections for more information.

Ordering Information

Model 515 Standard Mount Paddlewheel

When choosing this style of sensor, the instrument can be mounted nearby on a pipe or wall or in a remote location up to 60 m/200 ft (standard cable length is 7.6 m/25 ft) by connecting the sensor through a standard 3-8050-1 universal junction box. Use Signet fittings for proper seating of the sensor into the process flow.

Model 515 Standard Paddlewheel Flow Sensor

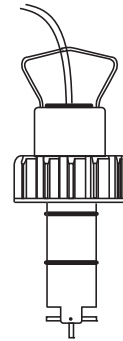

Sensor Part Number	
P51530	Flow Sensor for use with remote mount instrument
↓	Body/Rotor/Pin Material-Choose One*
	- H Polypropylene/Black PVDF/Hastelloy-C
	- P Polypropylene/Black PVDF/Titanium
	- S Polypropylene/Black PVDF/Natural PVDF
	- T Natural PVDF/Natural PVDF/Natural PVDF
	- V Natural PVDF/Natural PVDF/Hastelloy-C
	Pipe Size - Choose One
0	½ to 4 in.
1	5 to 8 in.
2	10 to 36 in.
↓	
P51530	- P 0 Example Part Number

Mfr. Part No.*	Code	Mfr. Part No.*	Code
P51530-H0	198 801 659	P51530-T0	198 801 663
P51530-P0	198 801 620	P51530-T1	198 801 664
P51530-P1	198 801 621	P51530-V0	198 801 623
P51530-P2	198 801 622	P51530-V1	198 801 624
P51530-S0	198 801 661	P51530-V2	198 801 625

*Model 515

Ordering Notes

- 1) Most common part number combinations shown. For all other combinations contact factory.
- 2) Other rotor and pin materials are available for purchase from the factory and can be easily replaced in the field. See Accessories section.

Model 515 Integral Mount Paddlewheel

When choosing this style of sensor, the instrument is mounted directly onto the sensor for a local display. See Guideline below for instructions.

Sensor Part Number		
3-8510	Flow Sensor for integral mounting on the 8150 or 8550 instrument using the 3-8051 adapter (instrument and adapter sold separately)	
↓	Body/Rotor/Pin Material-Choose One*	
	- P Polypropylene/Black PVDF/Titanium	
	- T Natural PVDF/Natural PVDF/Natural PVDF**	
	- V Natural PVDF/Natural PVDF/Hastelloy-C**	
	Pipe Size - Choose One	
	0	½ to 4 in.
	1	5 to 8 in. (PP only)
↓		
3-8510	- P 0 Example Part Number	

**PVDF available ½ in. to 4 in. only

Mfr. Part No.*	Code	Mfr. Part No.*	Code
3-8510-P0	198 864 504	3-8510-T0	159 000 622
3-8510-P1	198 864 505	3-8510-V0	198 864 506

Model 515 Integral Mount Paddlewheel Flow Sensor

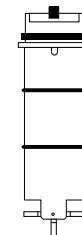

Guideline: Combining a 515 Integral mount flow sensor with an integrally mounted instrument Option 1

Once an integral mount sensor is chosen, it can be mounted directly to a field mount transmitter by following these guidelines:

- a) Order the integral adapter kit 3-8051 (sold separately) to connect the sensor to an instrument.
- b) Order a field mount transmitter (sold separately). The following part numbers are compatible: 3-8550-1, 3-8550-2, 3-8550-3, 3-8150-1.

- c) Assembling the sensor with the integral adapter and instrument is quick and simple.

Option 2

These parts can also be ordered as an assembled part. See page 74 "Integral Mount" for more information.

Signet 515 Wet-Tap Sensor with the 3519 Wet-Tap Valve

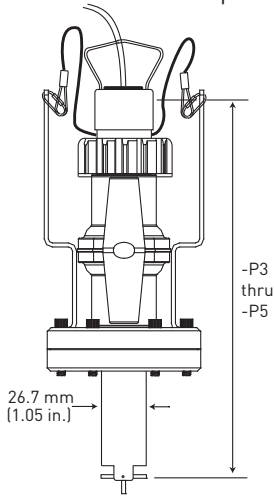

Pipe Range
 ½ to 4 in. -P3 = 297 mm (11.7 in.)
 5 to 8 in. -P4 = 333 mm (13.1 in.)
 10 in. and up -P5 = 409 mm (16.1 in.)

***Model 515
 Ordering Notes**

- Other rotor and pin materials are available for purchase from the factory and can be easily replaced in the field. See Accessories section.

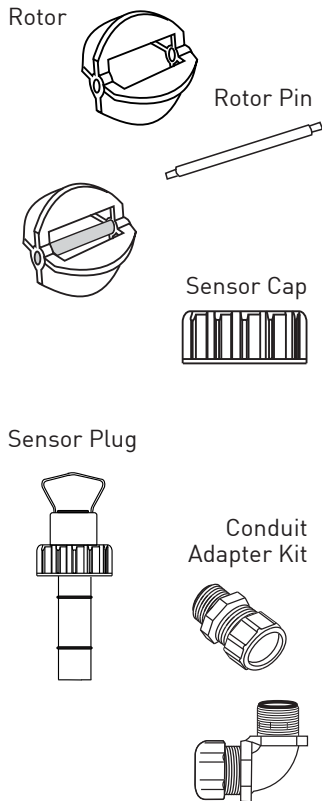

Ordering Information (continued)

Model 515 Wet-Tap Mount Paddlewheel Flow Sensor

When choosing this style of sensor, the instrument can be mounted nearby on a pipe or wall or in a remote location up to 60 m (200 ft) by connecting the sensor through a standard 3-8050-1 universal junction box. Standard cable length is 7.6 m (25 ft). This style of sensor uses the 3519 Wet-Tap valve only (see individual product page for more information).

Sensor Part Number	
P51530	Flow Sensor for wet-tap mounting with the 3519 Wet-Tap Valve (sold separately)
↓	Body/Rotor/Pin Material*
	- P Polypropylene/Black PVDF/Titanium
	Pipe Size - Choose One
	3 ½ to 4 in.
4 5 to 8 in.	
5 10 to 36 in.	
↓	
P51530	- P 3 Example Part Number

Mfr. Part No.*	Code
P51530-P3	198 840 310
P51530-P4	198 840 311
P51530-P5	198 840 312

Guideline: Combining a 515 Wet-Tap Sensor with a 3519 Wet-Tap Valve

- Sensor can be mounted in a 3519 Wet-Tap Valve (sold separately)
- Assembling a sensor with a 3519 Wet-Tap valve is quick and simple. These parts can also be ordered as complete assemblies. See 3519 product page.

Accessories and Replacement Parts

Mfr. Part No.	Code	Description
Rotors		
M1538-2	198 801 181	Rotor, PVDF Black
P51547-3	159 000 474	Rotor, PVDF Natural
M1538-4	198 820 018	Rotor, Tefzel®
P51550-3	198 820 043	Rotor and pin (matched set), PVDF Natural
3-0515.322-1	198 820 059	Sleeved rotor, PVDF Black
3-0515.322-2	198 820 060	Sleeved rotor, PVDF Natural
3-0515.322-3	198 820 017	Sleeved rotor, Tefzel®
Rotor Pins		
M1546-1	198 801 182	Pin, Titanium
M1546-2	198 801 183	Pin, Hastelloy-C
M1546-3	198 820 014	Pin, Tantalum
M1546-4	198 820 015	Pin, Stainless Steel
P51550-3	198 820 043	Rotor and pin, PVDF Natural
P51545	198 820 016	Pin, Ceramic
O-Rings		
1220-0021	198 801 186	O-ring, FPM (2 required per sensor)
1224-0021	198 820 006	O-ring, EPR (EPDM) (2 required per sensor)
1228-0021	198 820 007	O-ring, FFPM (2 required per sensor)
Miscellaneous		
P31536	198 840 201	Sensor plug, Polypropylene
P31542	198 801 630	Sensor cap, Red
P31934	159 000 466	Conduit cap
P51589	159 000 476	Conduit adapter kit
5523-0222	159 000 392	Cable (per foot), 2 cond. w/shield, 22 AWG
3-8051	159 000 187	Transmitter integral adapter (for use with 8510 and 8512) (see system overview for graphics)
6400-9001	159 001 466	Intrinsic safety barriers (2 required)
3-8051-1	159 000 753	Universal junction box